

HITPOINT

TEL:8862-26013311

FAX:8862-26013898

NO.4 Lane 505, Zhongzheng Rd., Linkou Shiang, Taipei, Taiwan 24445 . R.O.C

Magnetic Buzzer PB-09S27PW-03Q

(ROHS)

DATE:2014.03.31

1 . Electrical Characteristics

VER .:2

Oscillation Frequency (Hz)	2731
Operating Voltage (Vp-p)	2.0 ~ 4.0
Rated Voltage (Vp-p)	3.0
Current Consumption (mA/max)	80 at Rated Voltage
Sound Pressure Level (dB/min)	85 at 10cm at Rated Voltage
Coil Resistance (Ω)	15 ± 2
Operating Temperature ($^{\circ}\text{C}$)	$-20 \sim +70$
Storage Temperature ($^{\circ}\text{C}$)	$-30 \sim +80$
Condition by reflow soldering ($^{\circ}\text{C}$)	$250 \pm 5^{\circ}\text{C}$ / within 5sec
Condition by hand ($^{\circ}\text{C}$)	$350 \pm 20^{\circ}\text{C}$ / within 5sec

PS : Vp-p= 1/2duty , square wave

2 . Typical Frequency Response Curve

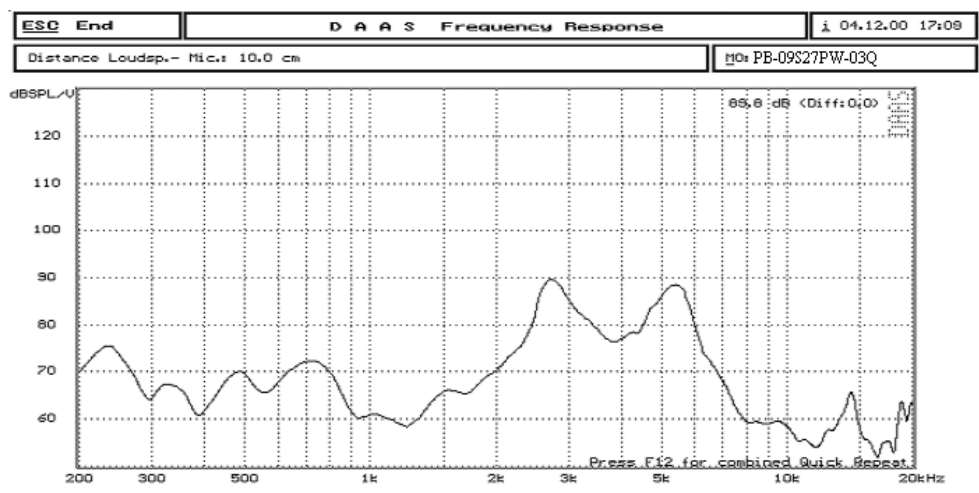

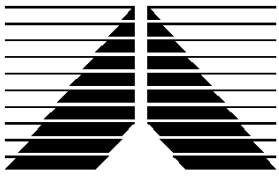

HITPOINT

TEL:8862-26013311

FAX:8862-26013898

NO.4 Lane 505, Zhongzheng Rd., Linkou Shiang, Taipei, Taiwan 24445 . R.O.C

3 . Dimensions and Material

3-1 Shape

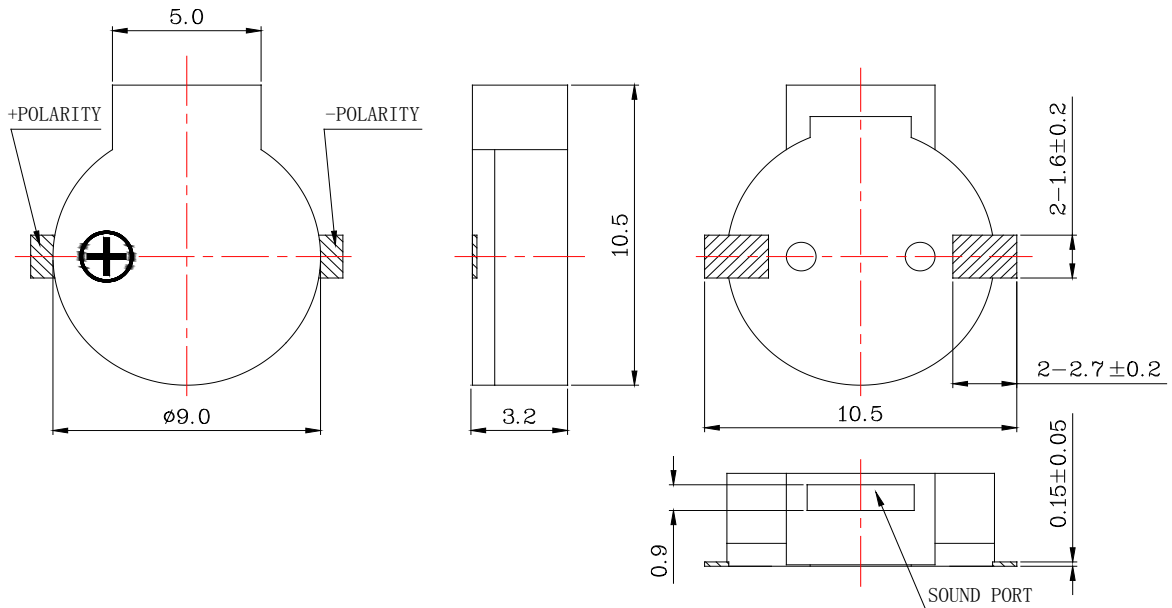

Unit : mm

3-2 Material

Housing	LCP (Color : Black)
Leading Pin	Tin Plated Brass
Weight (Gram)	0.4

4 . Recommend Driving Circuit

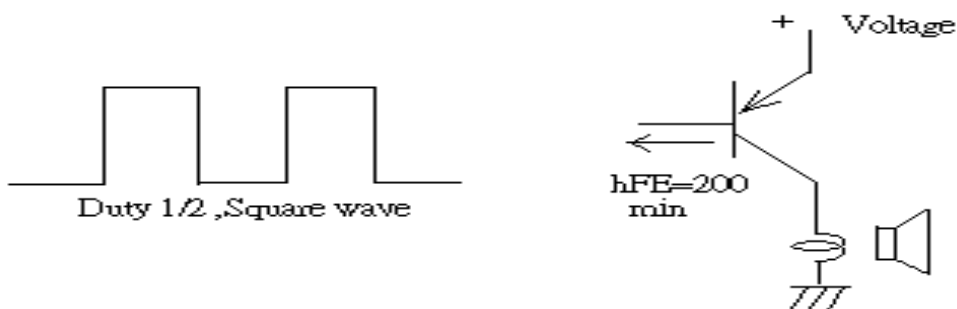

The base current I_b should high enough so that it saturates the collector current of the transistor with the CB load.

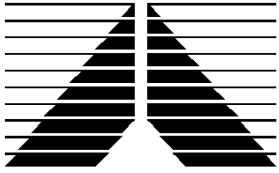

HITPOINT

TEL:8862-26013311

FAX:8862-26013898

NO.4 Lane 505, Zhongzheng Rd., Linkou Shiang, Taipei, Taiwan 24445 . R.O.C

5. TESTING METHOD

· *Standard Measurement conditions*

Temperature:25±2 °C Humidity:45-60%

· *Acoustic Characteristics*

The oscillation frequency, current consumption and sound pressure are measured by the measuring instruments shown below.

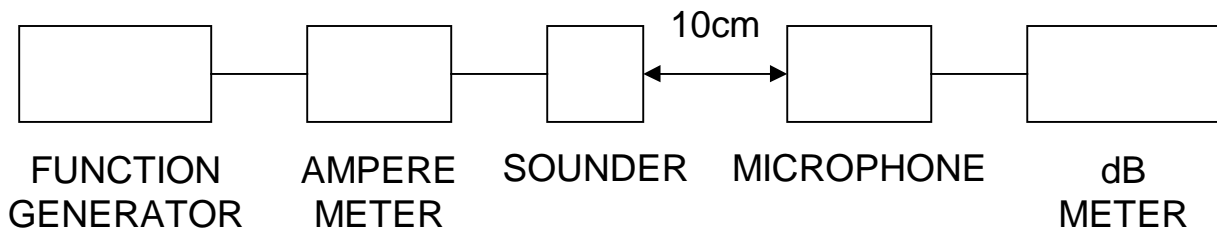

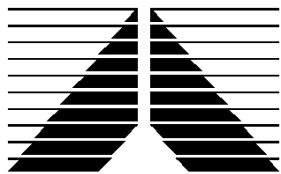

HITPOINT

TEL:8862-26013311

FAX:8862-26013898

NO.4 Lane 505, Zhongzheng Rd., Linkou Shiang, Taipei, Taiwan 24445 . R.O.C

6. RELIABILITY

ITEMS	METHOD OF TEST AND MEASUREMENTS	PERFORMANCE
<i>Coldness withstanding</i>	<i>After 98 hours of being exposed to -30°C environment, should be returned to normal environment for 2 hours, then re-proceed to test.</i>	<i>No abnormality shall exist</i>
<i>Hotness withstanding</i>	<i>After 98 hours of being exposed to +80°C environment, should be returned to normal environment for 2 hours, then re-proceed to test.</i>	<i>No abnormality shall exist</i>
<i>Humidity withstanding</i>	<i>After 98 hours of being exposed to 40°C 95%RH environment in actual operation, should be returned to normal environment for 2 hours, then re-proceed to test.</i>	<i>No abnormality shall exist</i>
<i>Durability</i>	<i>Testing after 1,000 hours actual continuous operation. (at standard measurement conditions)</i>	<i>No abnormality shall exist</i>
<i>Drop withstanding</i>	<i>A natural drop from 75cm high down to the ground.</i>	<i>No abnormality shall exist</i>
<i>Vibration withstanding</i>	<i>Vibration of 2,000 cycles per minute, 2mm amplitude, applied in X, Y and Z directions for 30 minutes each.</i>	<i>No abnormality shall exist</i>

7. PACKAGE METHOD

<1> 1000pcs per reel, Total 8 reels per carton, total 8000pcs per carton;

Volume: L*W*H=520*335*290mm

<2>N . W . : 3.2KGS ; G . W . : 4.4KGS ;

<3> RoHS Mark: